

Varenummer: 0125052  
 Beskrivelse: Seeger låsering SP35  
 Fjederstål

## Mål

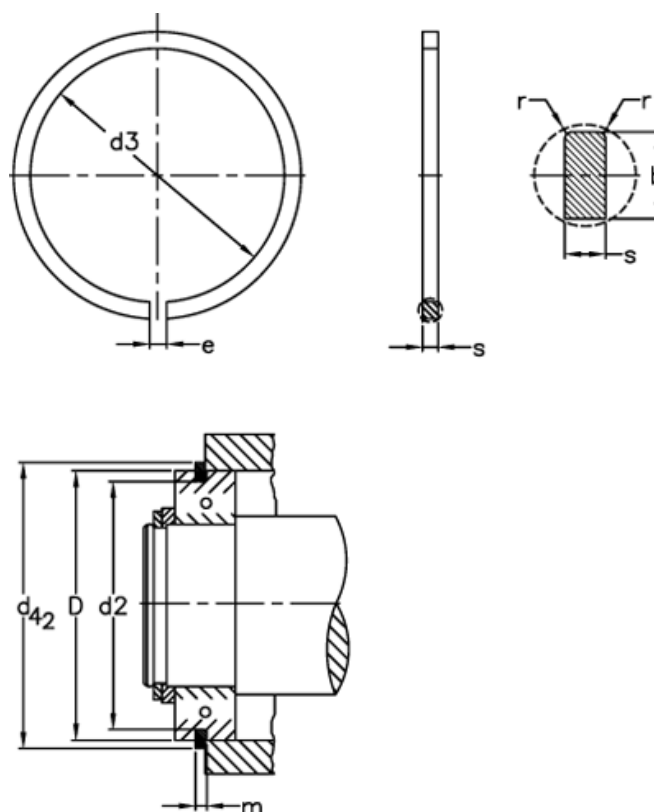

b	= 3.25	FRg kN	= 2.42	tol	= -0.15
Betegnelse	= SP 35	FR kN	= 13.4	tol	= -0.1
D	= 35	g	= 2.0	tol	= -0.25
d2	= 33.17	K kN-mm	= 28.0	tol	= 0.3
d3	= 32.4	m	= 1.35	tol	= 0.4
d42	= 39.7	n abl x 1000	= 11.0	vægt kg/1000	= 3.2
e	= 3	r min	= 0.4		
FN kN	= 16.0	s	= 1.12		